

PIN	DESCRIPTION
1	+24V DC
2	n/a
3	GND
4	IO-Link Kommunikation

ART.-NO. SENSOR X	NAME
07300.0-00	SEN073 (temperature / humidity), IP65
07300.1-00	SEN073 (temperature / humidity), IP20, 1m
07300.1-01	SEN073 (temperature / humidity), IP20, 2m
07301.0-00	SEN073 (pressure / temperature), IP65
07302.0-00	SEN073 (light), IP65

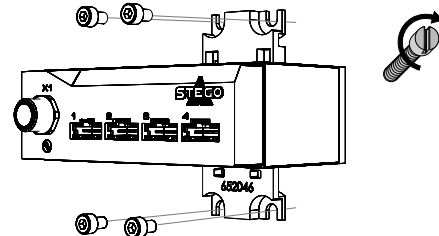
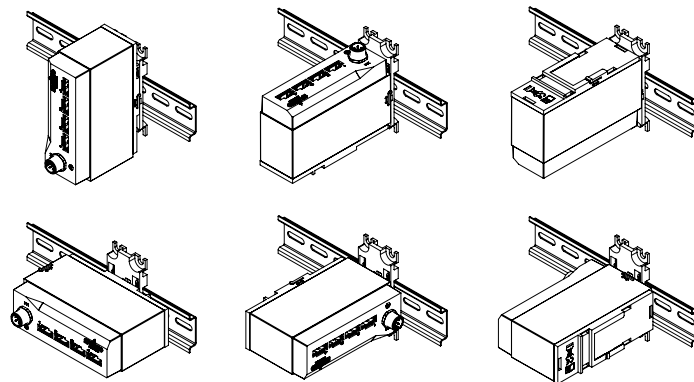
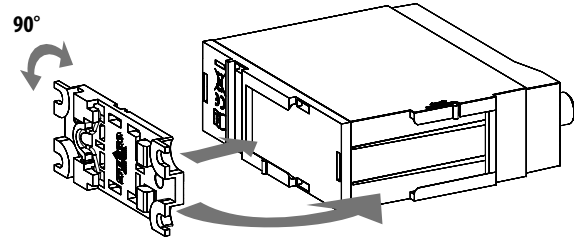

! WARNING
Bei Missachtung der Anschlusswerte oder falscher Polung besteht die Gefahr von Personen- und Geräteschädigungen!

! WARNING
There is a risk of personal injury and equipment damage if the connection values are not observed or polarity is incorrect!

! AVERTISSEMENT
Le non-respect des valeurs de raccordement ou une mauvaise polarité peut engendrer des dommages corporels et matériels !

! ADVERTENCIA
En caso de no respetar los valores de conexión o realizar una polaridad errónea, existe el peligro de lesionar a las personas o dañar los equipos.

! AVVERTENZA
Il mancato rispetto dei valori di collegamento o una polarità falsa può causare danni a persone e cose!

! ATENÇÃO
No caso de inobservância dos valores de conexão ou no caso de conexão incorreta dos polos, existe o perigo de ferimentos e danos no aparelho!

! VARNING
Om anslutningsvärden åsidosätts eller vid polningsfel finns risk för person- och materialskador!

! VAROVÁNÍ
V případě nerespektování přípojných hodnot nebo nesprávné polarity hrozí nebezpečí úrazů a poškození zařízení!

! OSTRZEŻENIE
W przypadku nieprzestrzegania wymaganych parametrów przyłącza albo niewłaściwej biegunowości powstaje zagrożenie urazami ludzi i uszkodzeniem urządzenia!

! ОСТОРОЖНО
при несоблюдении подключаемых значений или неверной полярности существует опасность травм персонала и повреждений оборудования!

IO-Link

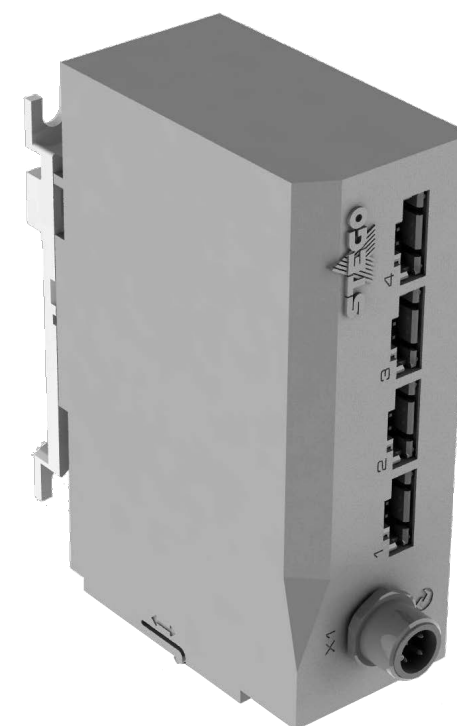

STEGO Elektrotechnik GmbH - Kolpingstrasse 21 - 74523 Schwaebisch Hall Germany - www.stego.de

EVENTS (EXAMPLE FOR ONE TEMPERATURE/HUMIDITY-SENSOR)

EVENT	SET 1		RESET 0	
	temperature T [°C]	humidity RH [%]	temperature T [°C]	humidity RH [%]
alarm high	T 1.1	H 1.1	T 1.0	H 1.0
range high	T 2.1	H 2.1	T 2.0	H 2.0
range low	T 3.1	H 3.1	T 3.0	H 3.0
alarm low	T 4.1	H 4.1	T 4.0	H 4.0

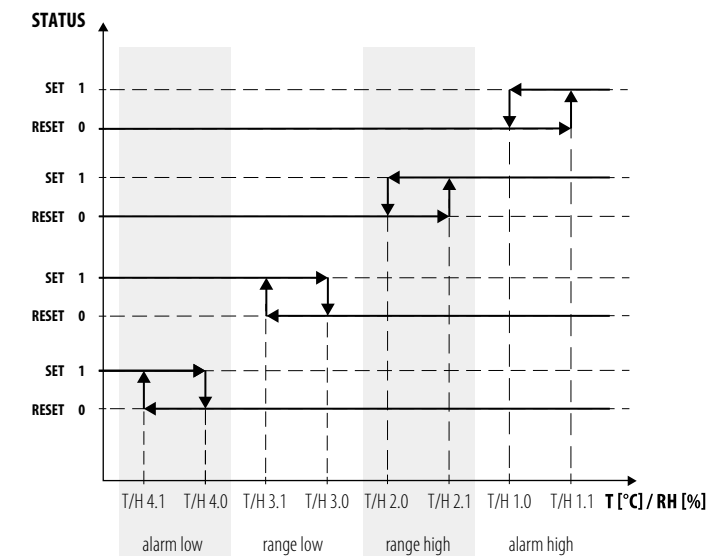

DIAGNOSIS

Device status
Error counter
Operating hours
Power-On counter
Event counters for max. and min. temperature and humidity values
Event counters for adjustable temperature and humidity parameters
Temperature and humidity histogram-data
Reset counters for temperature and humidity events
Reset whole parameter (NOTE: Password required „stego“)

EXAMPLE

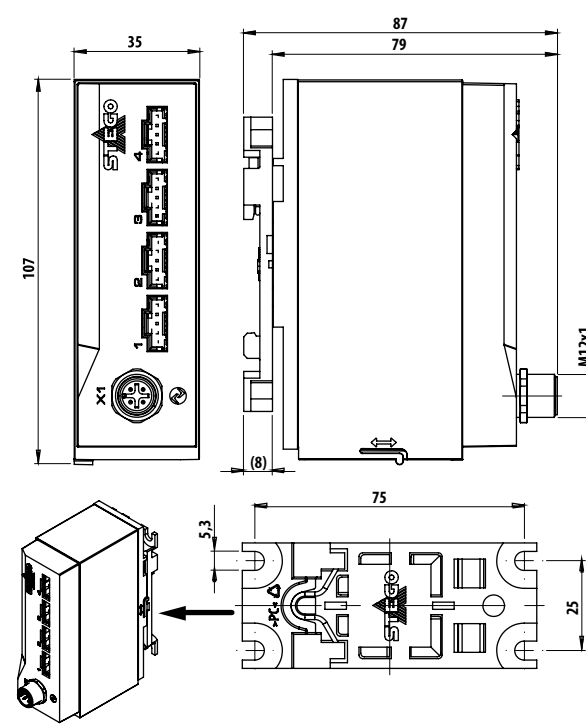
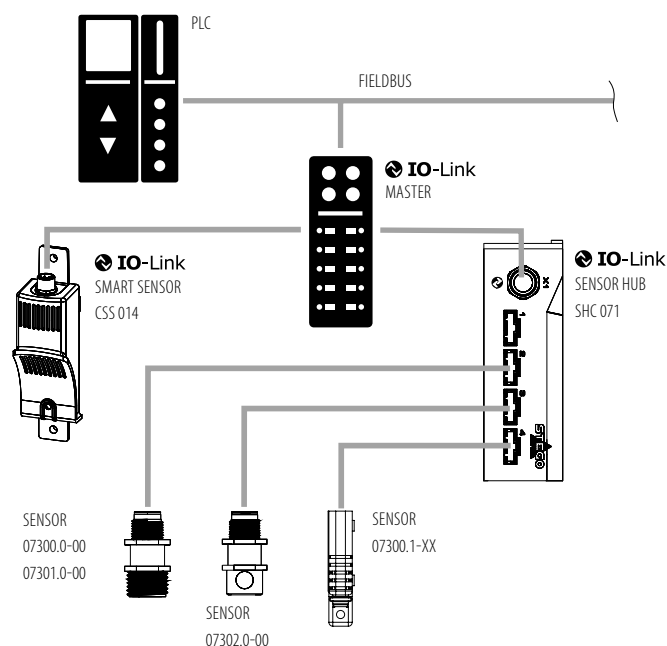

Temperature: -40 ... +80°C (-40 ... +176°F)

Humidity: max. 90% RH

Weight: 110 g

Power: DC 24V (18 ... 30V), P max. 0.5W

Torque: 2 Nm max. (17.7 lb-in)

Type SHC 071

Zum späteren Gebrauch aufbewahren. Store for use at a later date.

IP40

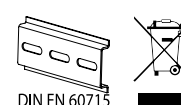

681228 07/2020

